

THE WIDEST RANGE IN MINIATURE SWITCHES



- 17 actuators including toggles, paddle levers and locking levers in different lengths.
- Various contact materials for low and high currents.
- 8 functions including maintained and momentary versions.
- 1 to 4 pole configurations.



- 12 terminal types including 9 for PC board mounting. Other types include quick-connect and wire-wrap.
- 6 bushing styles from 6 (.236) plain to 11,9 (15/32) threaded.
- 3 types of finish including military black.



- 3 approvals (UL - CSA - CECC).
- 4 types of sealing for terminal or front panel requirements.
- Numerous accessories available for actuator and bushing options.

5000 series

Toggle switches

Overview



A

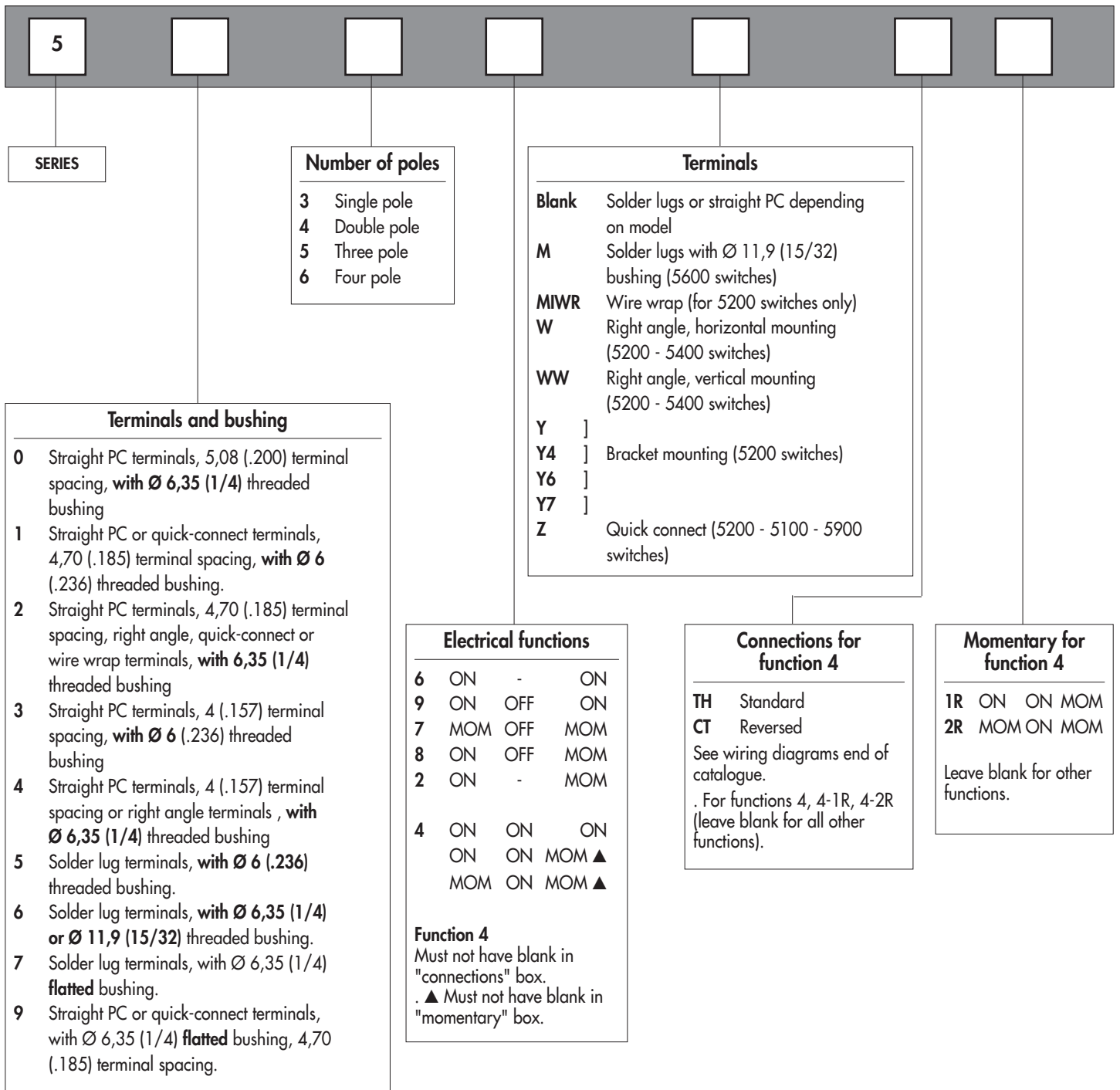

ABOUT THIS SERIES

- On the following pages, you will find successively :
- model structure of switches with threaded bushing
 - model structure of switches with plain bushing
 - options in the same order as in above chart

Dimensions : first dimensions are in mm while inches are shown as bracketed numbers.



NOTICE : please note that not all combinations of above numbers are available. Refer to the following pages for further information.



5000 series

Toggle switches

Overview

A

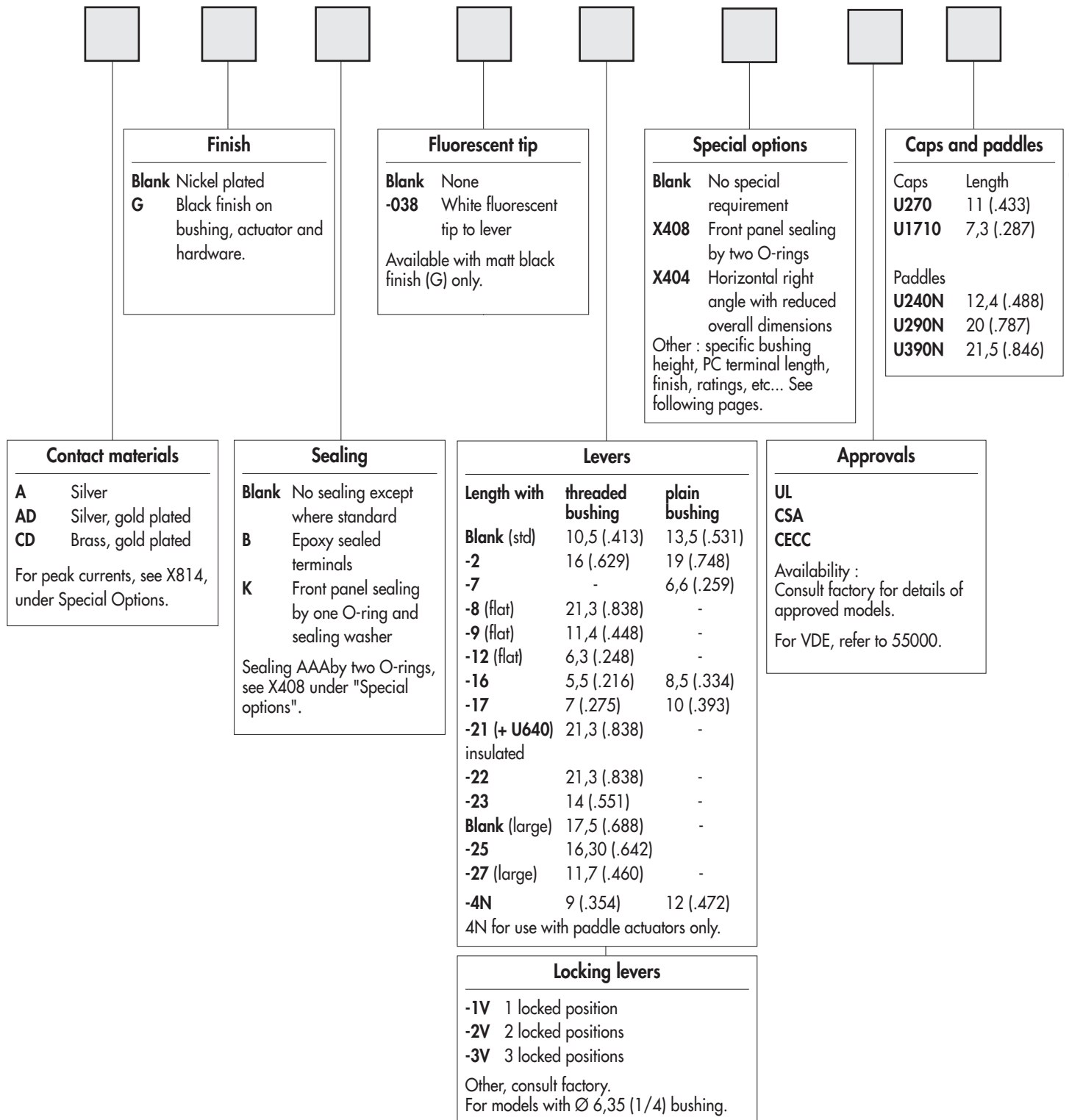

Sealing boots are available. They are presented in section H.



Mounting accessories : standard hardware supplied with all models with Ø 6,35 (1/4) or Ø 6 (.236) threaded bushing : 2 hex nuts 8 mm (.314) across flats, 1 locking ring and 1 lockwasher. Standard and special hardware available are presented in section I.



Packaging unit : 25 pieces or 50 pieces depending on models.

5000 series

Toggle switches

Specifications

ELECTRICAL SPECIFICATIONS

- Current/voltage rating with resistive load :

Contact	Maximum	Minimum	Level*
Silver (A)	4A 30VDC	50mA 10VDC	III and IV
Silver, gold plated (AD)	4A 30VDC Gold plating withstands up to 100mA 30VDC	10mA 50mV 10µA 5V	I to IV
Brass, gold plated (CD)	0,4 VA at 20VAC or DC	10mA 50mV 10µA 5V	I and II

- For inductive, lamp or capacitive load, consult factory. * For details, see Technical Information, end of catalogue.
- Initial contact resistance : 10 mΩ max.
- Insulation resistance : 1.000 MΩ min. at 500VDC
- Dielectric strength :
 - 1.000 Vrms 50 Hz min. between terminals
 - 1.500 Vrms 50 Hz min. between poles
 - 1.500 Vrms 50 Hz min. between terminals and frame
- Contact bounce : 2 ms max.
- Electrical life at full load :
 - 50.000 cycles for single and double pole
 - 40.000 cycles for 3 pole
 - 30.000 cycles for 4 pole
- Low level or mechanical life : 100.000 cycles

MATERIALS

- Case : diallylphthalate (DAP) or high temperature plastic material (UL94-V0)
- Actuator : brass, nickel plated
- Paddles : UL94HB polyamide
- Lever caps : vinyl
- Bushing : brass, nickel plated
- Housing : stainless steel or steel tin plated
- Contacts
 - A** : silver
 - AD** : silver, gold plated
 - CD** : brass, gold plated
 - X814** : for peak currents, see "Special options".
- Terminal seal : epoxy

GENERAL SPECIFICATIONS

- Torque : 1,25 Nm (.922 Ft.lb) max. applied to nut
- Panel thickness : 2,5 mm (.098) with 2 nuts - 4 mm (.157) with 1 nut
- Operating temperature : -40°C to +85°C

AGENCY APPROVALS/PREFERENTIAL LIST



CECC 96201-007

3A 250VAC, 6A 125VAC

For **VDE**, refer to 55000 series.

NATO

Availability : consult factory for details of approved models.

Marking : to order switches marked UL, CSA or CECC, complete appropriate box of ordering format. The preferential list does not appear on the switches.



5000 series

Toggle switches - solder lug terminals

Threaded bushing Ø 6,35 (1/4) : 5600

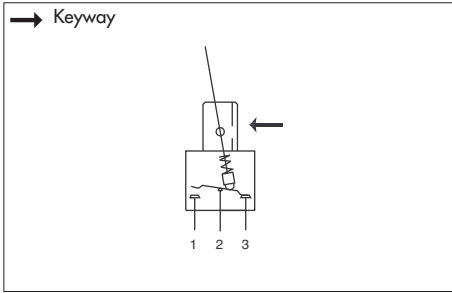

- 1, 2, 3 and 4 pole configurations

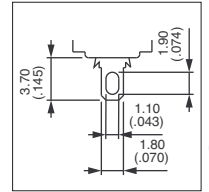

MODEL STRUCTURE

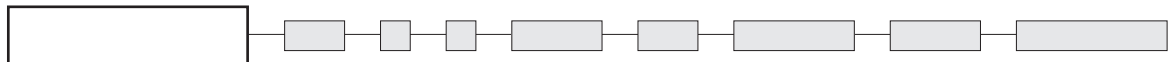

Shown with standard lever

Single pole



5636
5639
5637
5638
5632

III	II	I
2-3		1-2
ON	-	ON
ON	OFF	ON
MOM	OFF	MOM
ON	OFF	MOM
ON	-	MOM

→ Keyway

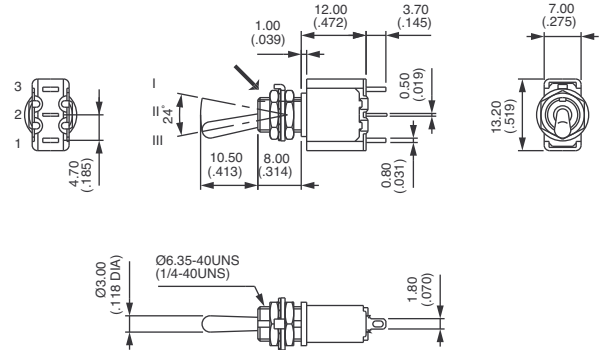

Double pole



5646
5649
5647
5648
5642
5644*
5644 1R*
5644 2R*

III	II	I
2-3		1-2
5-6		4-5
ON	-	ON
ON	OFF	ON
MOM	OFF	MOM
ON	OFF	MOM
ON	-	MOM
ON	ON	ON
ON	ON	MOM
MOM	ON	MOM

→ Keyway

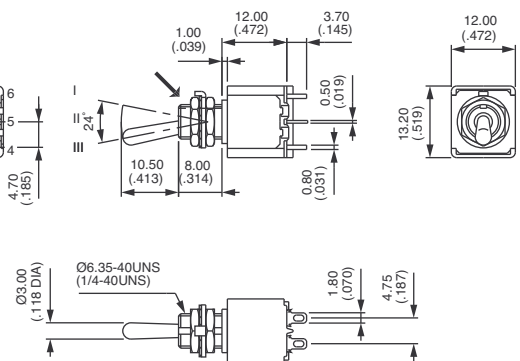

* Function 4 : SP in DP case - specify CT or TH connections, see end of catalogue.

Three pole



5656
5659
5657
5658
5652

III	II	I
2-3		1-2
5-6		4-5
8-9		7-8
ON	-	ON
ON	OFF	ON
MOM	OFF	MOM
ON	OFF	MOM
ON	-	MOM

→ Keyway

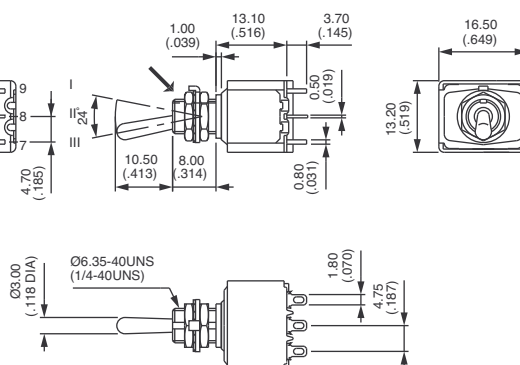

5000 series

Toggle switches - solder lug terminals

Threaded bushing $\varnothing 6,35$ (1/4) : 5600



A

Four pole



- 5666
- 5669
- 5667
- 5668
- 5662
- 5664*
- 5664 1R*
- 5664 2R*

III	II	I
2-3		1-2
5-6		4-5
8-9		7-8
11-12		10-11
ON	-	ON
ON	OFF	ON
MOM	OFF	MOM
ON	OFF	MOM
ON	-	MOM
ON	ON	ON
ON	ON	MOM
MOM	ON	MOM

→ Keyway

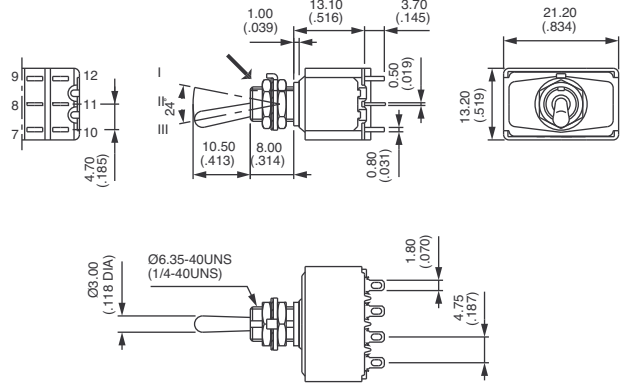

*Function 4 : DP in 4P case - specify CT or TH connections, see end of catalogue.

PANEL CUT-OUT

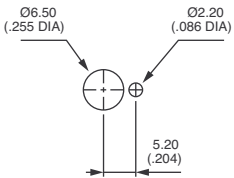

Standard

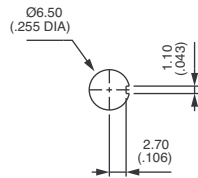

With K
sealing option

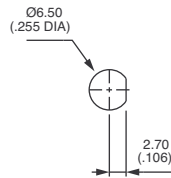

With X408
sealing option



5000 series

Toggle switches - solder lug terminals

A

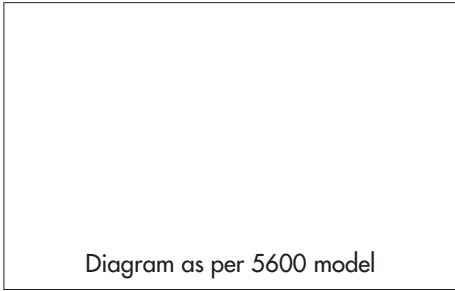

5700 models

- Flatted bushing $\varnothing 6,35$ mm (1/4)
- 1, 2, 3 and 4 pole configurations

MODEL STRUCTURE

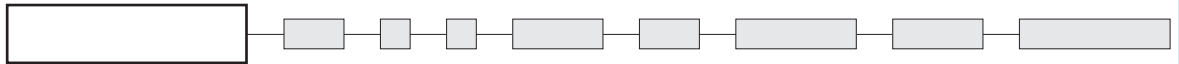

For model structure numbers, refer to 5600 models and replace 6 with 7.

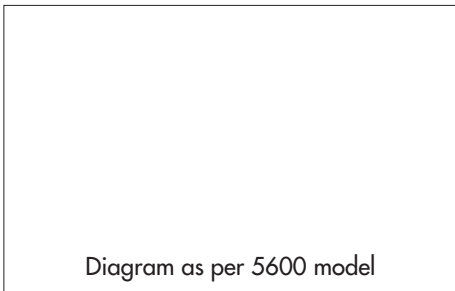
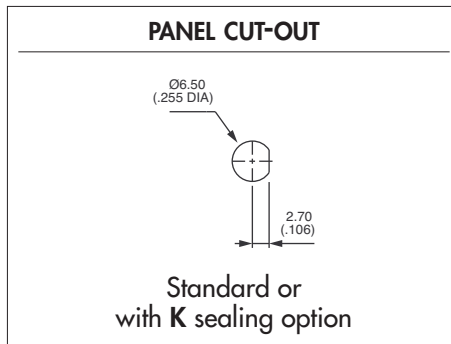

5500 models

- Threaded bushing $\varnothing 6$ mm x 0.75 SI (.236 x 0.75 IS)
- 1, 2, 3 and 4 pole configurations

MODEL STRUCTURE

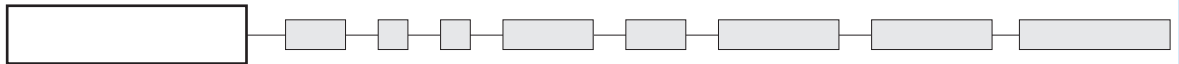

For model structure numbers, refer to 5600 models and replace 6 with 5.

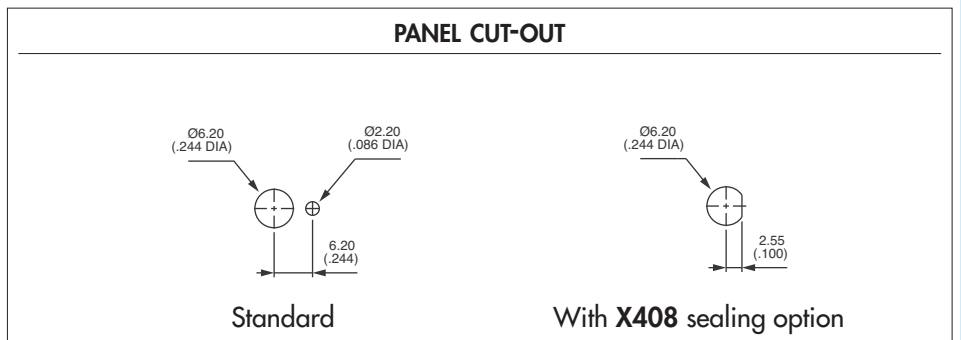

5000 series

Toggle switches - solder lug terminals

Threaded bushing \varnothing 11,9 (15/32) : 5600M

MODEL
STRUCTURE

→ Keyway

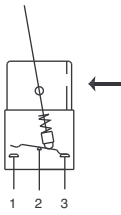

- 1, 2, 3 and 4 pole configurations
- Supplied with 2 hex nuts and 1 locking ring
- Panel thickness up to 6 mm (.236)

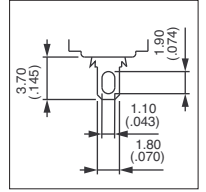

MODEL
STRUCTURE

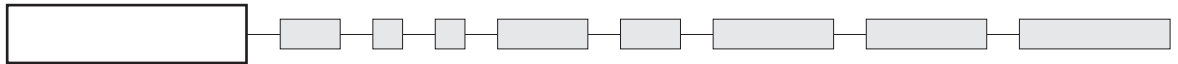

Shown with standard lever

Single pole



5636M
5639M
5637M
5638M
5632M

III	II	I
2-3		1-2
ON	-	ON
ON	OFF	ON
MOM	OFF	MOM
ON	OFF	MOM
ON	-	MOM

→ Keyway

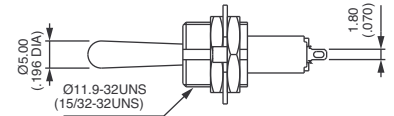
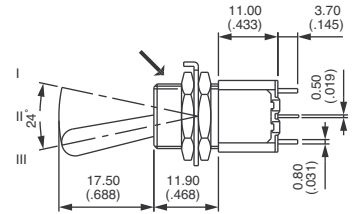
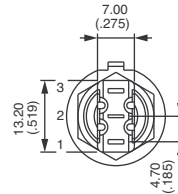

Double pole



5646M
5649M
5647M
5648M
5642M
5644M*
5644M 1R*
5644M 2R*

III	II	I
2-3		1-2
5-6		4-5
ON	-	ON
ON	OFF	ON
MOM	OFF	MOM
ON	OFF	MOM
ON	-	MOM
ON	ON	ON
ON	ON	MOM
MOM	ON	MOM

→ Keyway

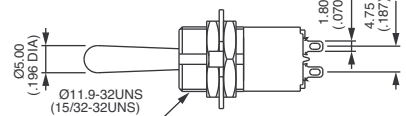
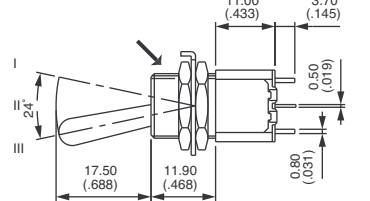
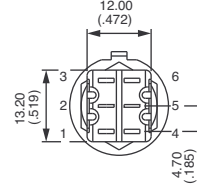

* Function 4 : SP in DP case - specify CT or TH connections, see end of catalogue.

Three pole



5656M
5659M
5657M
5658M
5652M

III	II	I
2-3		1-2
5-6		4-5
8-9		7-8
ON	-	ON
ON	OFF	ON
MOM	OFF	MOM
ON	OFF	MOM
ON	-	MOM

→ Keyway

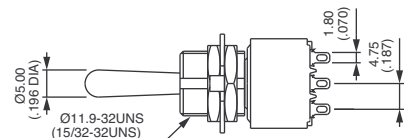
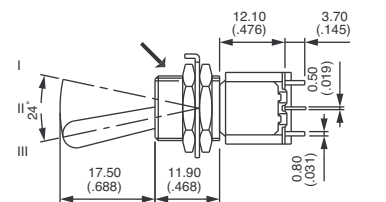
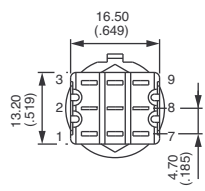



5000 series

Toggle switches - solder lug terminals

Threaded bushing $\varnothing 11,9$ (15/32) : 5600M

Four pole



5666M
5669M
5667M
5668M
5662M
5664M*
5664M 1R*
5664M 2R*

III	II	I
2-3		1-2
5-6		4-5
8-9		7-8
11-12		10-11
	ON	- ON
	ON	OFF ON
	MOM	OFF MOM
	ON	OFF MOM
	ON	- MOM
	ON	ON ON
	ON	ON MOM
	MOM	ON MOM

→ Keyway

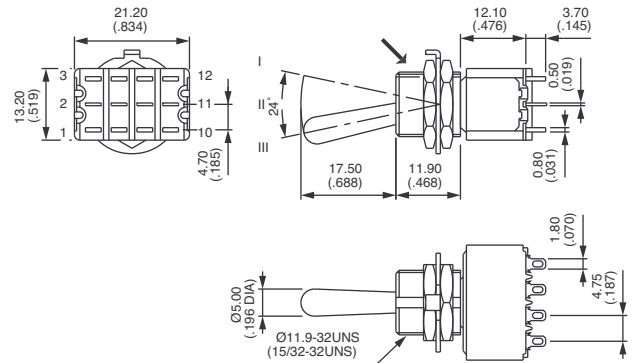

*Function 4 : DP in 4P case - specify CT or TH connections, see end of catalogue.

PANEL CUT-OUT

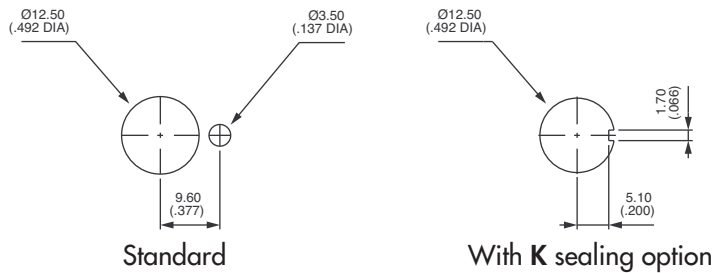

OTHER : M bushing can be combined with other types such as : 5200, Z, MIWR... Consult factory.

5000 series

Toggle switches - straight PC terminals

Threaded bushing \varnothing 6,35 (1/4) : 5200

MODEL
STRUCTURE

→ Keyway

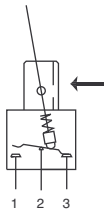

- Terminal spacing 4,7 mm (.185)
- 1, 2, 3 and 4 pole configurations
- Epoxy sealed terminals standard

For new projects, we recommend switches with support bracket (option Y) which holds the switch securely on the PCB.

Other terminal lengths presented under "Special options".

Also available with plain bushing, see "Special options" X371

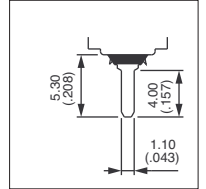

MODEL
STRUCTURE

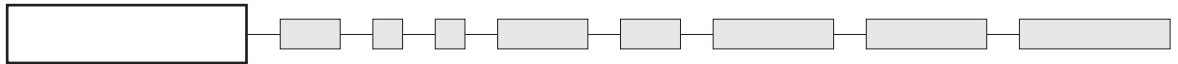

Shown with standard lever

Single pole



5236 B
5239 B
5237 B
5238 B
5232 B

III	II	I
2-3		1-2
ON	-	ON
ON	OFF	ON
MOM	OFF	MOM
ON	OFF	MOM
ON	-	MOM

→ Keyway

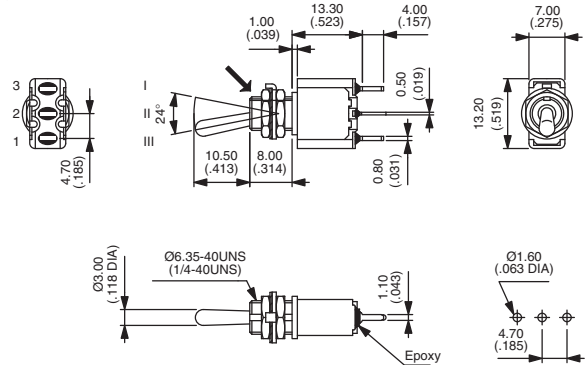

Double pole



5246 B
5249 B
5247 B
5248 B
5242 B
5244 B*
5244 1R B*
5244 2R B*

III	II	I
2-3		1-2
5-6		4-5
ON	-	ON
ON	OFF	ON
MOM	OFF	MOM
ON	OFF	MOM
ON	-	MOM
ON	ON	ON
ON	ON	MOM
MOM	ON	MOM

→ Keyway

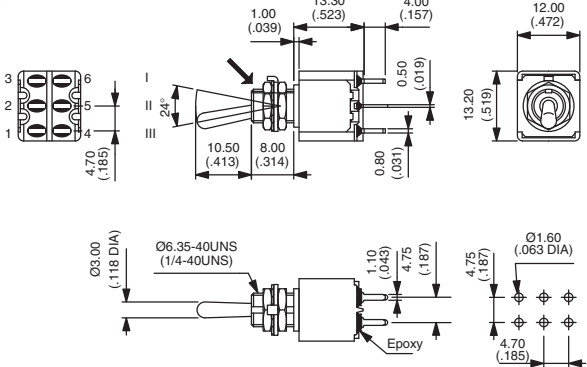

*Function 4 : SP in DP case - specify CT or TH connections, see end of catalogue.

Three pole



5256 B
5259 B
5257 B
5258 B
5252 B

III	II	I
2-3		1-2
5-6		4-5
8-9		7-8
ON	-	ON
ON	OFF	ON
MOM	OFF	MOM
ON	OFF	MOM
ON	-	MOM

→ Keyway

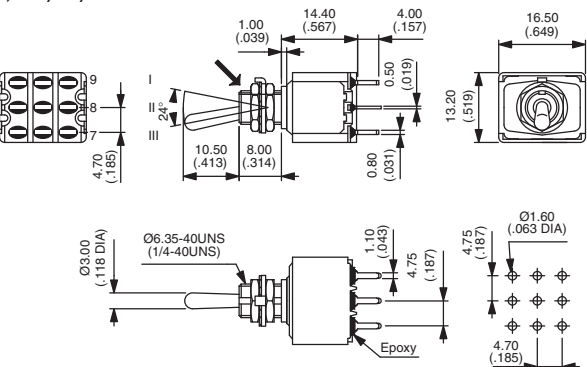



5000 series

Toggle switches - straight PC terminals

Threaded bushing Ø 6,35 (1/4) : 5200 - 5000

Four pole



- 5266 B
- 5269 B
- 5267 B
- 5268 B
- 5262 B
- 5264 B*
- 5264 1R B*
- 5264 2R B*

III	II	I
2-3		1-2
5-6		4-5
8-9		7-8
11-12		10-11
	ON - ON	
	ON OFF ON	
	MOM OFF MOM	
	ON OFF MOM	
	ON - MOM	
	ON ON ON	
	ON ON MOM	
	MOM ON MOM	

→ Keyway

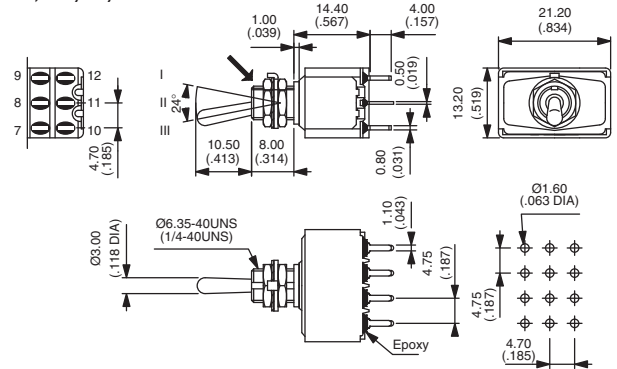

*Function 4 : DP in 4P case - specify CT of TH connections, see end of catalogue.

PANEL CUT-OUT

5200 - 5000 - 5400

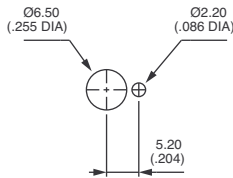

Standard

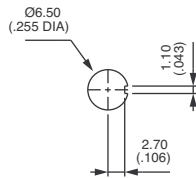

With K sealing option

5000 models

- Terminal spacing 5,08 mm (.200)
- Epoxy sealed terminals standard
- 1 and 2 pole configurations

Diagram as per 5200 model

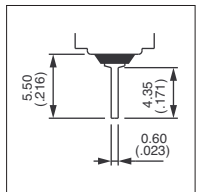

MODEL STRUCTURE

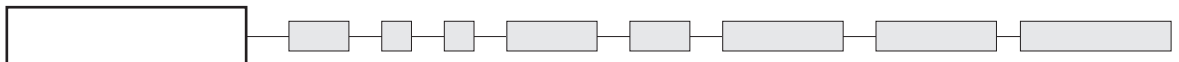

Shown with standard lever

Terminal spacing 5,08 (.200) - single and double pole

→ Keyway



- | Single pole | Double pole |
|-------------|-------------|
| 5036 | 5046 |
| 5039 | 5049 |
| 5037 | 5047 |
| 5038 | 5048 |
| 5032 | 5042 |
| | 5044* |
| | 5044 1R* |
| | 5044 2R* |

III	II	I
2-3		1-2
5-6		4-5
	ON - ON	
	ON OFF ON	
	MOM OFF MOM	
	ON OFF MOM	
	ON - MOM	
	ON ON ON	
	ON ON MOM	
	MOM ON MOM	

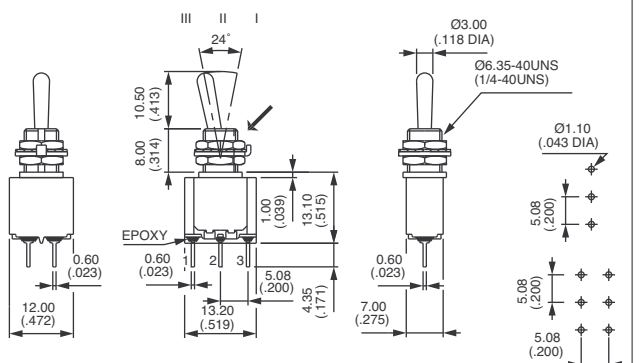

*Function 4 : SP in DP case - specify CT or TH connections, see end of catalogue.

5000 series

Toggle switches - straight PC terminals

MODEL
STRUCTURE

A

Diagram, as per 5200 model

5400 models

- Threaded bushing \varnothing 6,35 mm (1/4)
- Terminal spacing 4 mm (.157)
- 1, 2, 3 and 4 pole configurations

MODEL STRUCTURE

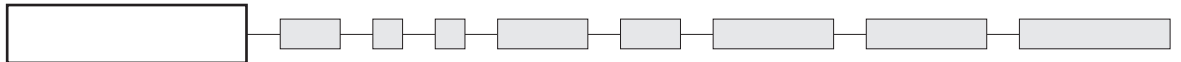

For model structure numbers, refer to 5200 models and replace 2 with 4.

Panel cut-out, see 5200.

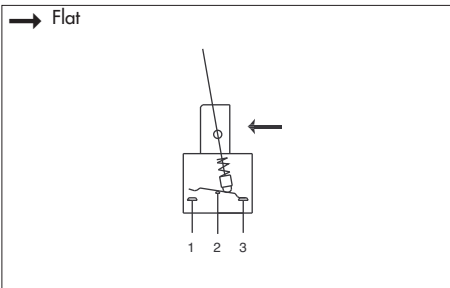

5900 models

- Flatted bushing \varnothing 6,35 mm (1/4)
- Terminal spacing 4,7 mm (.185)
- 1, 2, 3 and 4 pole configurations

MODEL STRUCTURE

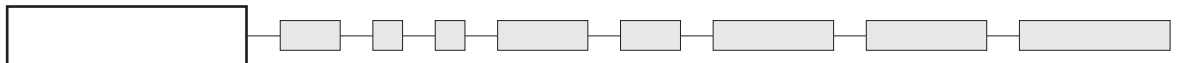

For model structure numbers, refer to 5200 models and replace 2 with 9.

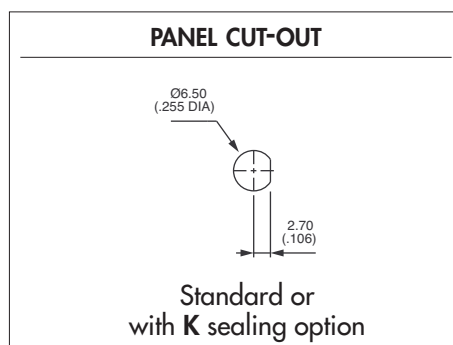



5000 series

Toggle switches - straight PC terminals

A

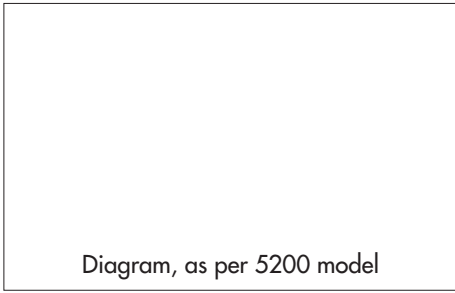

5100 models

- Threaded bushing $\varnothing 6 \text{ mm} \times 0.75 \text{ SI}$ (.236 x 0.75 IS)
- Terminal spacing 4,7 mm (.185)
- 1, 2, 3 and 4 pole configurations

MODEL
STRUCTURE

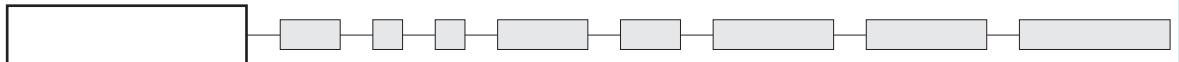

For model structure numbers, refer to 5200 models and replace 2 with 1.
Panel cut-out, see below.

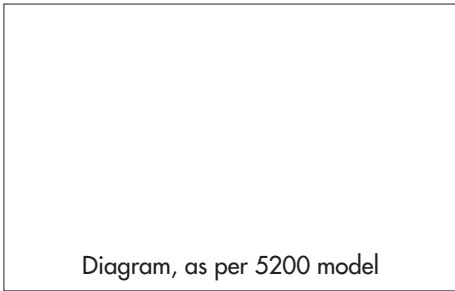

5300 models

- Threaded bushing $\varnothing 6 \text{ mm} \times 0.75 \text{ SI}$ (.236 x 0.75 IS)
- Terminal spacing 4 mm (.157)
- 1, 2, 3 and 4 pole configurations

MODEL
STRUCTURE

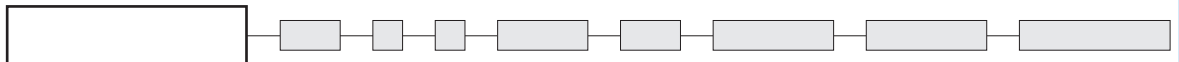

For model structure numbers, refer to 5200 models and replace 2 with 3.

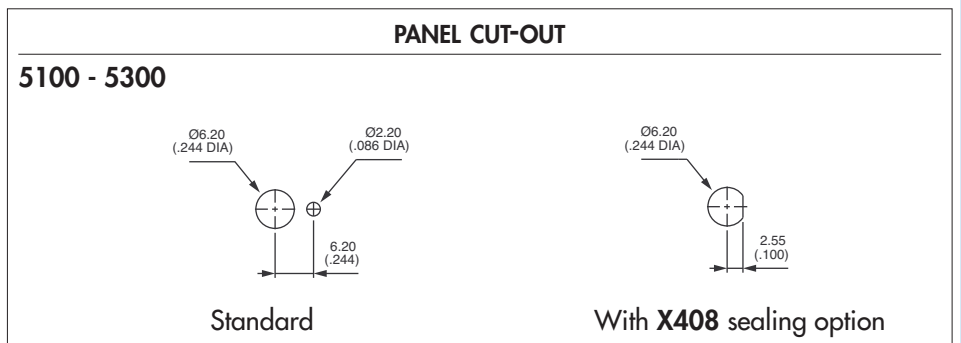

5000 series

Toggle switches - quick-connect terminals

Threaded bushing \varnothing 6,35 (1/4) : 5200Z

MODEL
STRUCTURE

→ Keyway

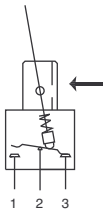

- Terminal spacing 4,7 mm (.185)
- Epoxy sealed terminals standard
- 1 and 2 pole configurations

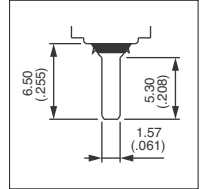

MODEL
STRUCTURE

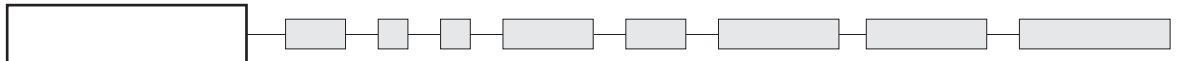

Shown with standard lever

Single pole



5236Z
5239Z
5237Z
5238Z
5232Z

III	II	I
2-3		1-2
ON	-	ON
ON	OFF	ON
MOM	OFF	MOM
ON	OFF	MOM
ON	-	MOM

→ Keyway

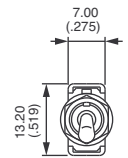
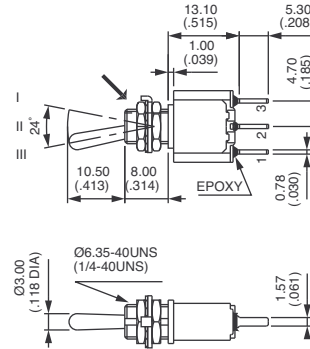

Double pole



5246Z
5249Z
5247Z
5248Z
5242Z
5244Z*
5244Z 1R*
5244Z 2R*

III	II	I
2-3		1-2
5-6		4-5
ON	-	ON
ON	OFF	ON
MOM	OFF	MOM
ON	OFF	MOM
ON	-	MOM
ON	ON	ON
ON	ON	MOM
MOM	ON	MOM

→ Keyway

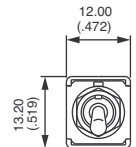
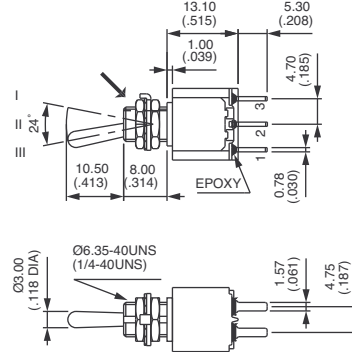

*Function 4 : SP in DP case - specify CT or TH connections, see end of catalogue.

PANEL CUT-OUT

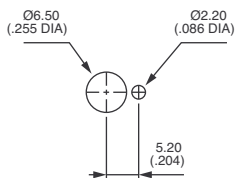

Standard

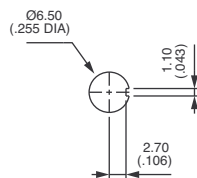

With K
sealing option

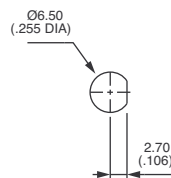

With X408
sealing option



5000 series

Toggle switches - quick-connect terminals

A

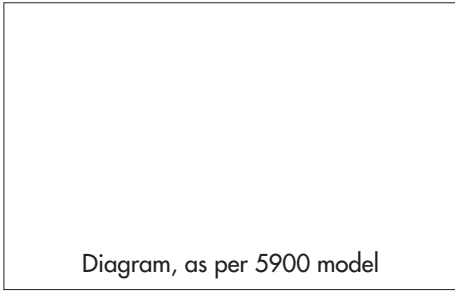

5900Z models

- Flatted bushing \varnothing 6,35 mm (1/4)
- Terminal spacing 4,7 mm (.185)
- Epoxy sealed terminals standard
- 1 and 2 pole configurations

MODEL STRUCTURE

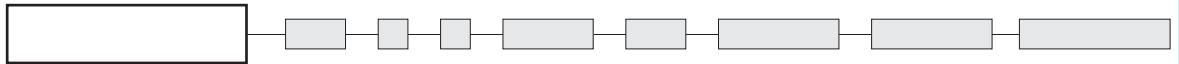

For model structure numbers, refer to 5200Z models and replace 2 with 9.

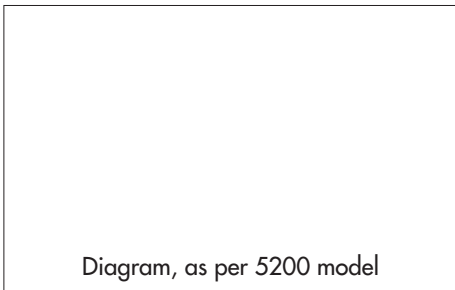
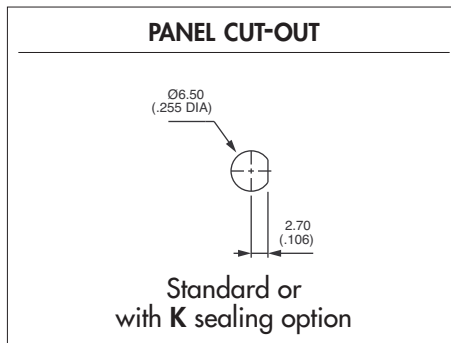

5100Z models

- Threaded bushing \varnothing 6 mm x 0.75 SI (.236 x 0.75 IS)
- Terminal spacing 4,7 mm (.185)
- Epoxy sealed terminals standard
- 1 and 2 pole configurations

MODEL STRUCTURE

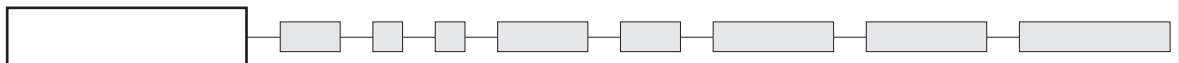

For model structure numbers, refer to 5200Z models and replace 2 with 1.

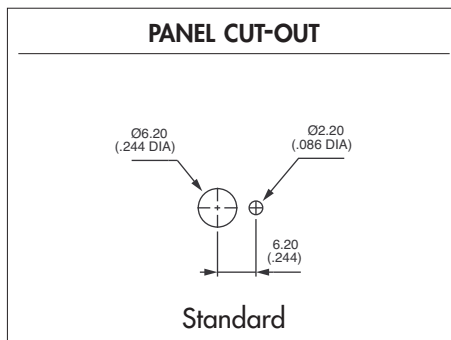

5000 series

Toggle switches - wire-wrap terminals

Threaded bushing $\varnothing 6,35 (1/4)$: 5200MIWR

MODEL
STRUCTURE

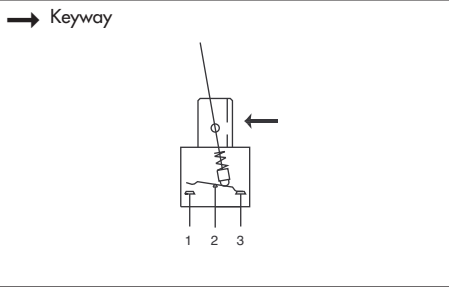

- Terminal spacing 5,08 mm (.200)
- Epoxy sealed terminals standard
- 1 and 2 pole configurations
- Can also be used as extended PCB terminals

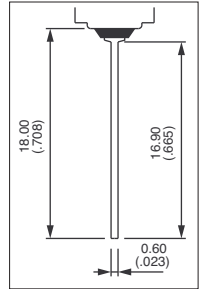

MODEL
STRUCTURE

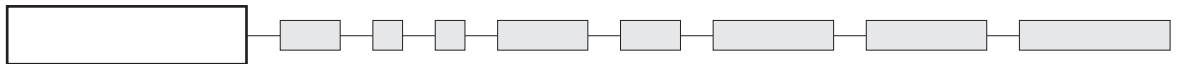

Shown with standard lever

Terminal spacing 5,08 (.200) - single pole



5236MIWR
5239MIWR
5237MIWR
5238MIWR
5232MIWR

III	II	I
2-3		1-2
ON	-	ON
ON	OFF	ON
MOM	OFF	MOM
ON	OFF	MOM
ON	-	MOM

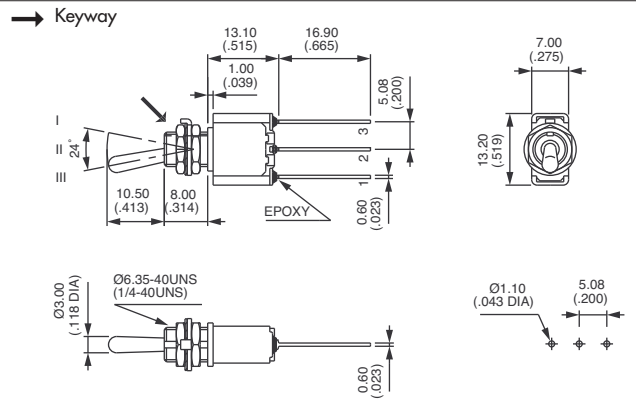

Terminal spacing 5,08 (.200) - double pole



5246MIWR
5249MIWR
5247MIWR
5248MIWR
5242MIWR
5244 1R MIWR*
5244 1R MIWR*
5244 2R MIWR*

III	II	I
2-3		1-2
5-6		4-5
ON	-	ON
ON	OFF	ON
MOM	OFF	MOM
ON	OFF	MOM
ON	-	MOM
ON	ON	ON
ON	ON	MOM
MOM	ON	MOM

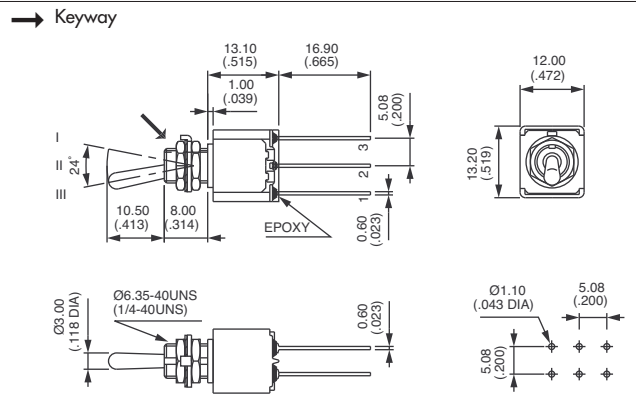

*Function 4 : SP in DP case - specify CT or TH connections, see end of catalogue.

PANEL CUT-OUT

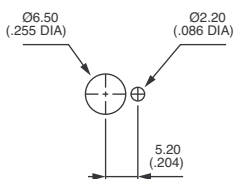

Standard

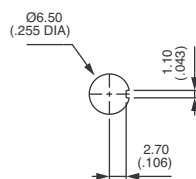

With K
sealing option

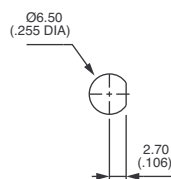

With X408
sealing option



5000 series

Toggle switches - plain bushing

Right angle terminals - horizontal : 5200W

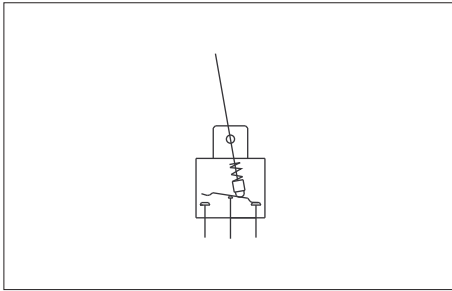

- Terminal spacing 4,7 mm (.185)
- 1, 2 and 3 pole configurations

Special switch **5200WX404** with reduced overall dimensions is presented under "Special options".

MODEL STRUCTURE

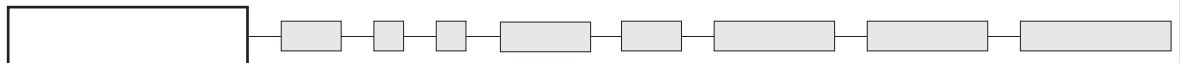

Shown with standard lever

Single pole



5236W
5239W
5237W
5238W
5232W

III	II	I
2-3		1-2
ON	-	ON
ON	OFF	ON
MOM	OFF	MOM
ON	OFF	MOM
ON	-	MOM

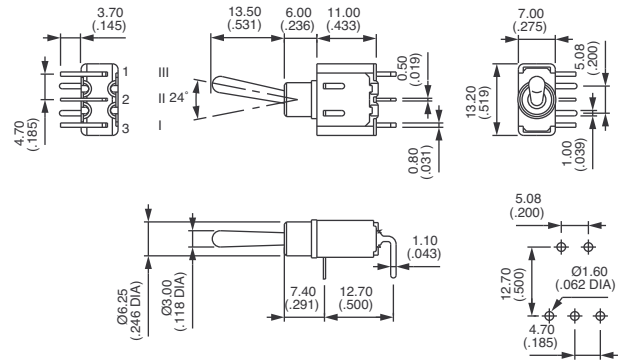

Double pole



5246W
5249W
5247W
5248W
5242W
5244W*
5244W 1R*
5244W 2R*

III	II	I
2-3		1-2
5-6		4-5
ON	-	ON
ON	OFF	ON
MOM	OFF	MOM
ON	OFF	MOM
ON	-	MOM
ON	ON	ON
ON	ON	MOM
MOM	ON	MOM

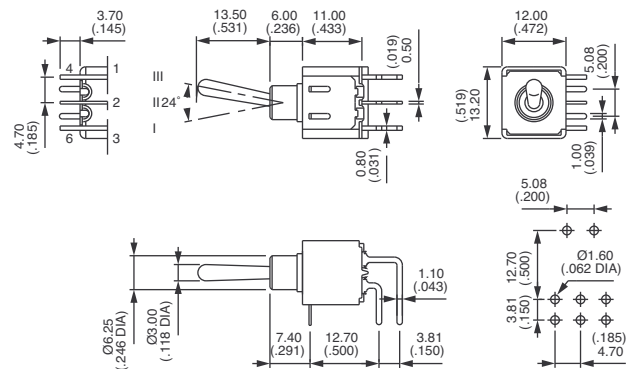

*Function 4 : SP in DP case - specify CT or TH connections, see end of catalogue.

Three pole



5256W
5259W
5257W
5258W
5252W

III	II	I
2-3		1-2
5-6		4-5
8-9		7-8
ON	-	ON
ON	OFF	ON
MOM	OFF	MOM
ON	OFF	MOM
ON	-	MOM

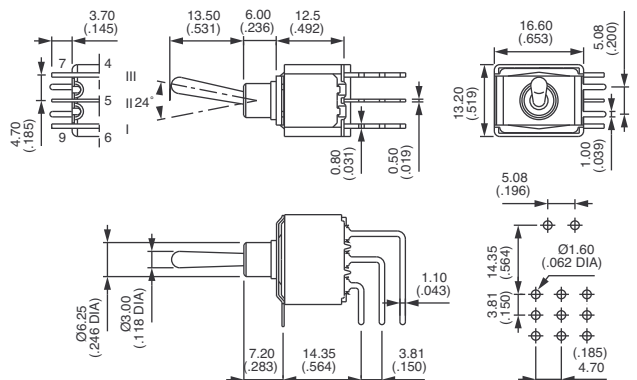

5000 series

Toggle switches - plain bushing

Right angle terminals - horizontal : 5400W

MODEL
STRUCTURE

PCB MOUNTING FOR 5200W

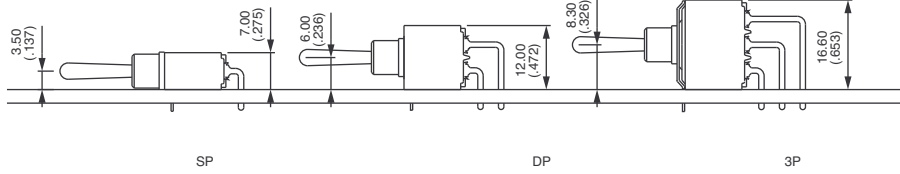

A

5400W models

- Terminal spacing 4 mm (.157)
- 1 and 2 pole configurations

Diagram, as per 5200W model

MODEL STRUCTURE



For model structure numbers, refer to **5200W** single and double pole and replace 2 with 4.

PC LAYOUT

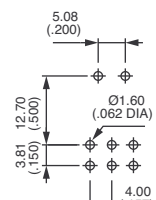
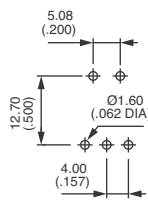

5000 series

Toggle switches - plain bushing

Right angle terminals - vertical : 5200WW - 5400WW



Four pole



- 5266WW
- 5269WW
- 5267WW
- 5268WW**
- 5262WW**
- 5264WW*
- 5264WW 1R*
- 5264WW 2R*

III	II	I
2-3		1-2
5-6		4-5
8-9		7-8
11-12		10-11
ON	-	ON
ON	OFF	ON
MOM	OFF	MOM
ON	OFF	MOM
ON	-	MOM
ON	ON	ON
ON	ON	MOM
MOM	ON	MOM

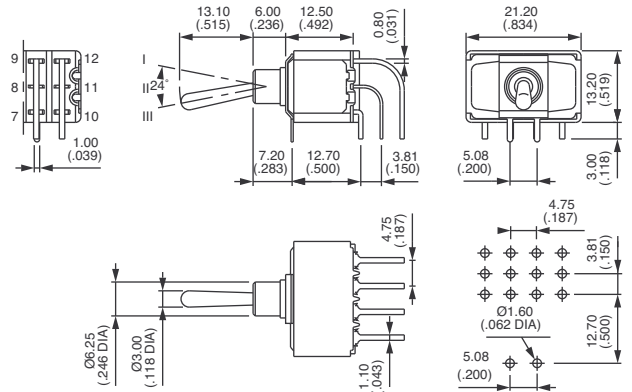

* Function 4 : SP in DP case, DP in 4P case - specify CT or TH connections, see end of catalogue.

** Functions 2 and 8 : reversed connection available, consult factory.

PCB MOUNTING

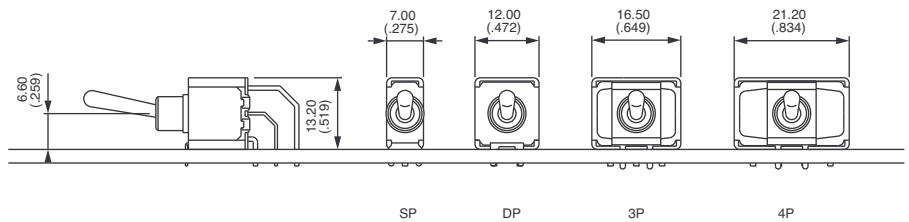

5400WW models

- Pin spacing 2,54 mm (.100)
- 1, 2, 3 and 4 pole configurations

Diagram as per 5200WW model

MODEL STRUCTURE

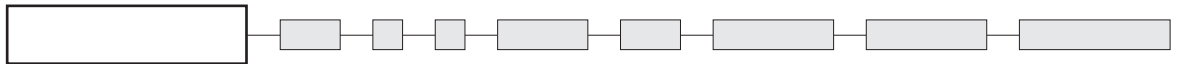

For model structure numbers, refer to 5200WW models and replace 2 with 4.

PC LAYOUT

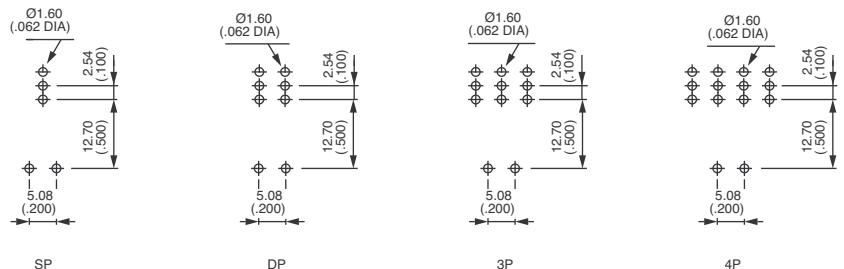



5000 series

Toggle switches - plain bushing

Straight PC terminals - bracket mounting : 5200Y

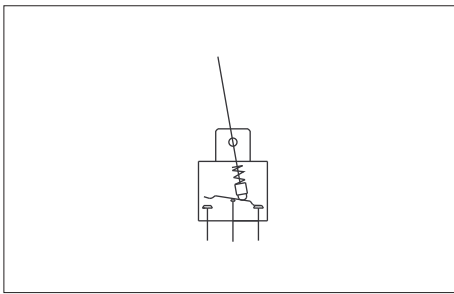

Brackets reduce mechanical stress on solder joints and increase resistance to vibrations.
Bracket material : tin plated steel.

- Epoxy sealed terminals standard
- 1 and 2 pole configurations

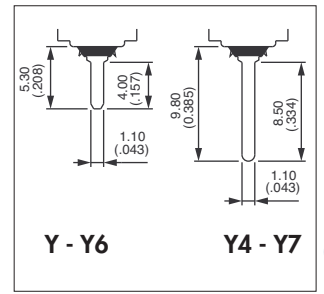

MODEL
STRUCTURE

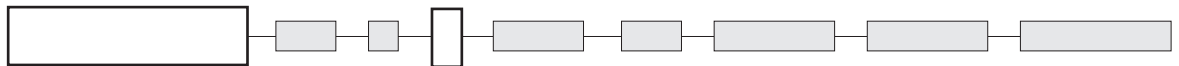

Shown with standard lever

Short bracket - width 15,75 (.620) - single pole : 5230Y



5236Y B
5239Y B
5237Y B
5238Y B
5232Y B

III	II	I
2-3		1-2

ON	-	ON
ON	OFF	ON
MOM	OFF	MOM
ON	OFF	MOM
ON	-	MOM

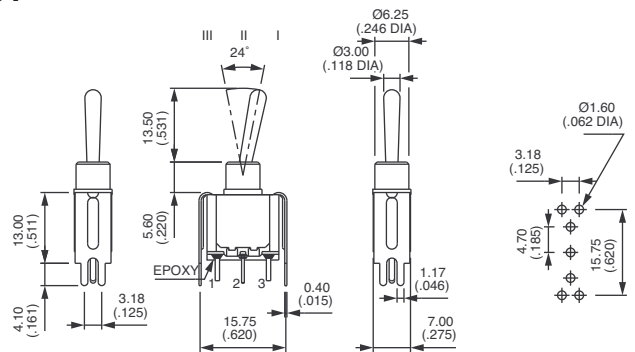

Short bracket - width 15,75 (.620) - double pole : 5240Y



5246Y B
5249Y B
5247Y B
5248Y B
5242Y B
5244Y B*
5244Y 1R B*
5244Y 2R B*

III	II	I
2-3		1-2
5-6		4-5

ON	-	ON
ON	OFF	ON
MOM	OFF	MOM
ON	OFF	MOM
ON	-	MOM
ON	ON	ON
ON	ON	MOM
MOM	ON	MOM

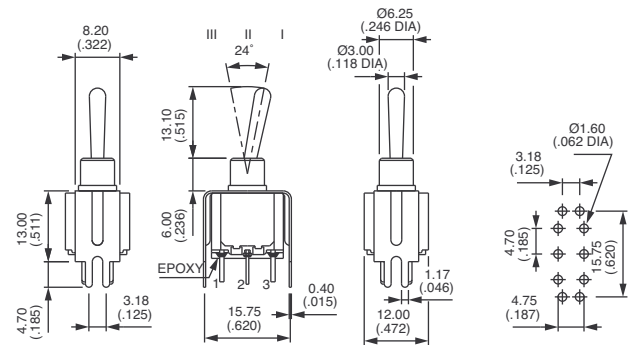

* Function 4 : SP in DP case - specify CT or TH connections, see end of catalogue.

5000 series

Toggle switches - plain bushing

Straight PC terminals - bracket mounting : 5200Y4 - Y6 - Y7

MODEL
STRUCTURE

Tall bracket - width 15,75 (.620) : 5200Y4



	III	II	I
Single pole	2-3		1-2
Double pole	5-6		4-5
5236Y4 B	ON	-	ON
5239Y4 B	ON	OFF	ON
5237Y4 B	MOM	OFF	MOM
5238Y4 B	ON	OFF	MOM
5232Y4 B	ON	-	MOM
5244Y4 B*	ON	ON	ON
5244Y4 1R B*	ON	ON	MOM
5244Y4 2R B*	MOM	ON	MOM

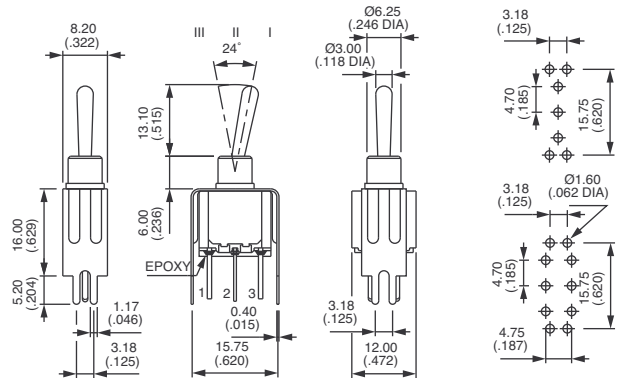

Short bracket - width 19,05 (.750) : 5200Y6



	III	II	I
Single pole	2-3		1-2
Double pole	5-6		4-5
5236Y6 B	ON	-	ON
5239Y6 B	ON	OFF	ON
5237Y6 B	MOM	OFF	MOM
5238Y6 B	ON	OFF	MOM
5232Y6 B	ON	-	MOM
5244Y6 B*	ON	ON	ON
5244Y6 1R B*	ON	ON	MOM
5244Y6 2R B*	MOM	ON	MOM

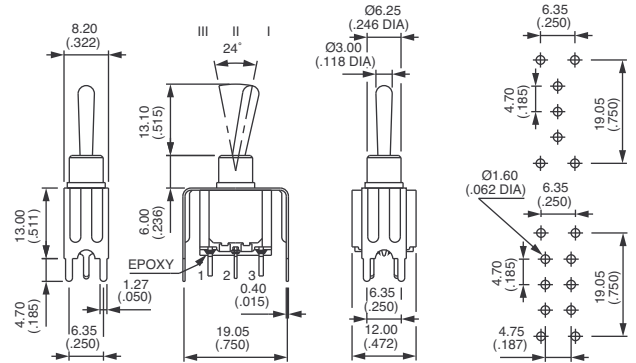

Tall bracket - width 19,05 (.750) : 5200Y7



	III	II	I
Single pole	2-3		1-2
Double pole	5-6		4-5
5236Y7 B	ON	-	ON
5239Y7 B	ON	OFF	ON
5237Y7 B	MOM	OFF	MOM
5238Y7 B	ON	OFF	MOM
5232Y7 B	ON	-	MOM
5244Y7 B*	ON	ON	ON
5244Y7 1R B*	ON	ON	MOM
5244Y7 2R B*	MOM	ON	MOM

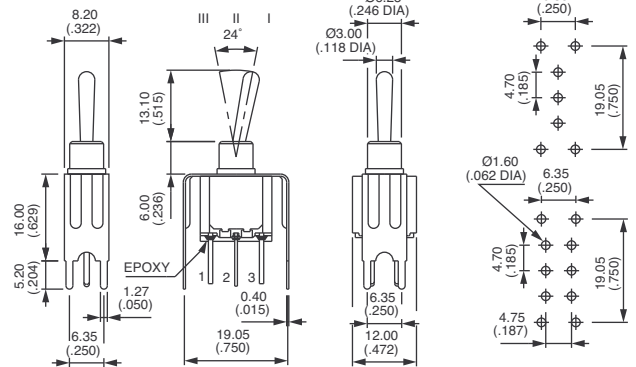

* Function 4 : SP in DP case - specify CT or TH connections, see end of catalogue.



CONTACT MATERIALS

UG1410A

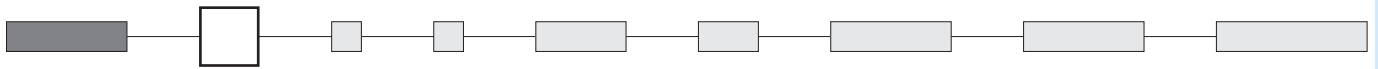

- A Silver
- AD Silver, gold plated
- CD Brass, gold plated

Special contacts for peak currents : see X814, under "Special Options".

FINISH

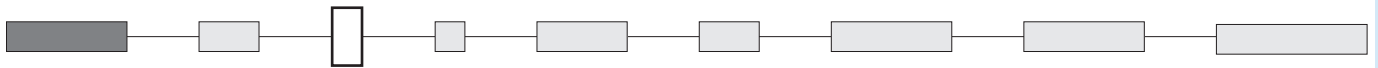

- Blank Nickel plated
- G Black finish on bushing, actuator and hardware

SEALING

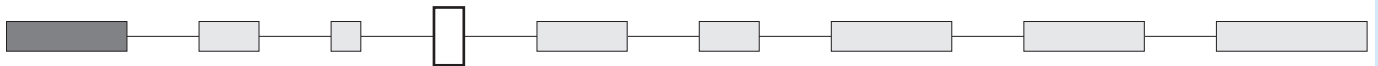

- Blank
 - For 5000 - 5200Z and 5200MIWR models : epoxy sealed terminals standard
 - Other models : no sealing required

- B Epoxy sealed terminals

- K Front panel sealing by one O-ring and sealing washer. Protects the switch against water and dust. Panel seal withstands 1 bar pressure and remains sealed even when switch is operated.

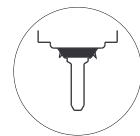

Available on models with $\varnothing 6,35$ (1/4) or $11,9$ (15/32) **threaded bushing only.**
Not available with levers 8, 9, 12, 22, 23.

- KB Combined sealings

- ① O-ring
- ② Sealing washer

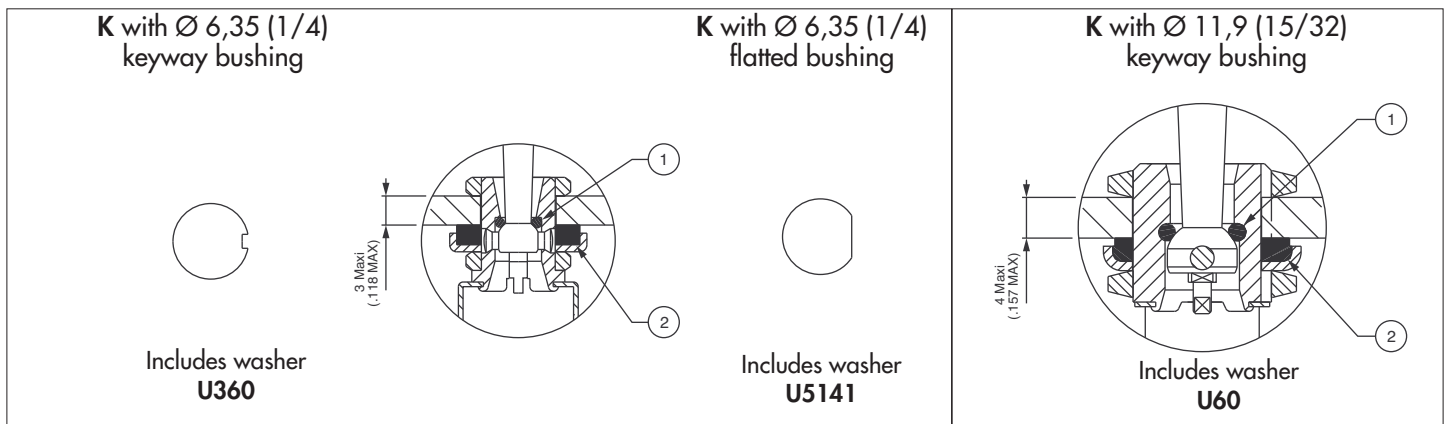

Sealing by two O-rings, see X408 under "Special options".

5000 series

Toggle switches

OPTIONS



FLUORESCENT TIP

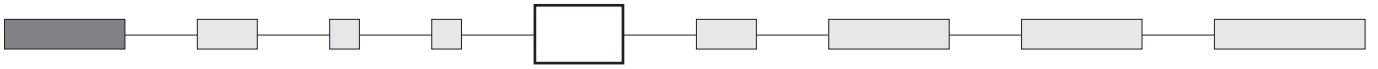

Blank None

Standard lever

Locking lever

-038 White fluorescent tip.
Becomes luminous when submitted to ultraviolet rays.



Available with matt black finish (option G) only.

Consult factory for levers available with this option.

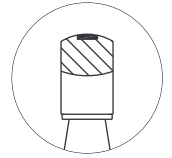
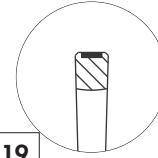

-19

Same dimensions as standard actuator below.

ACTUATORS

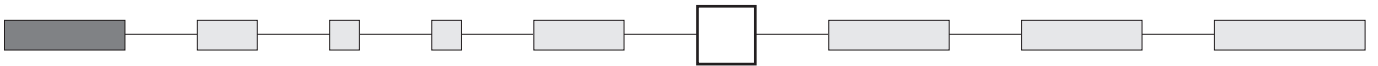

Levers for threaded bushing models $\varnothing 6,35$ (1/4) or $\varnothing 6$ (.236)

Dash compulsory before lever code.

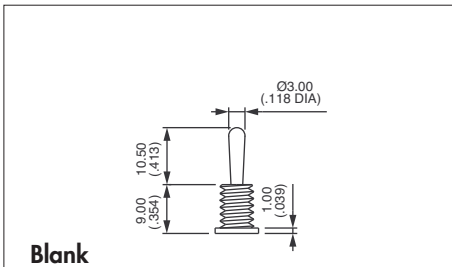

Blank

Standard

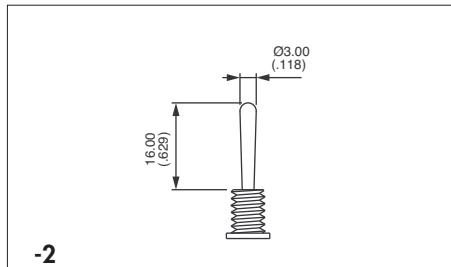

-2

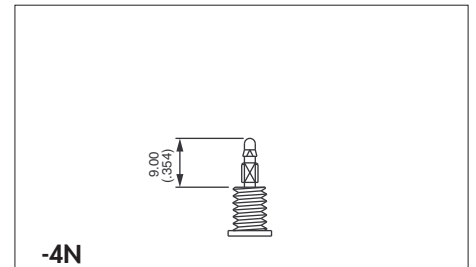

-4N

For use with paddles only

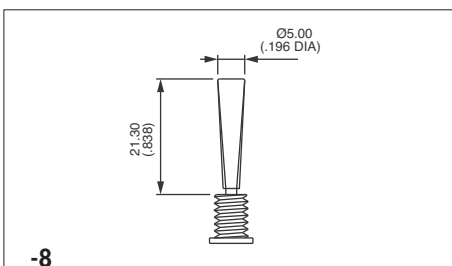

-8

Not available with sealing options K or X408

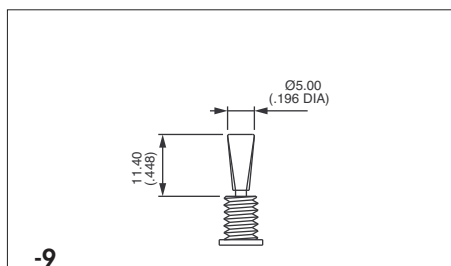

-9

Not available with sealing options K or X408

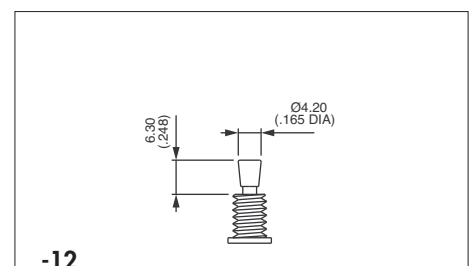

-12

Not available with sealing options K or X408

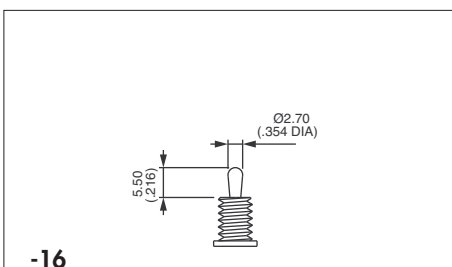

-16

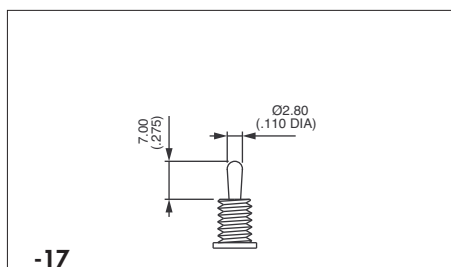

-17

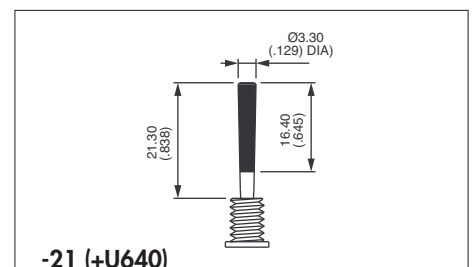

-21 (+U640)

U640 to be placed in last box of ordering format. Replace 0 by colour code.



A

ACTUATORS (continued)

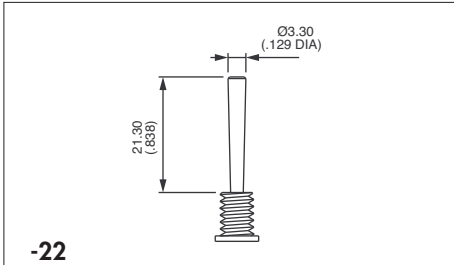

-22

Not available with sealing options K or X408

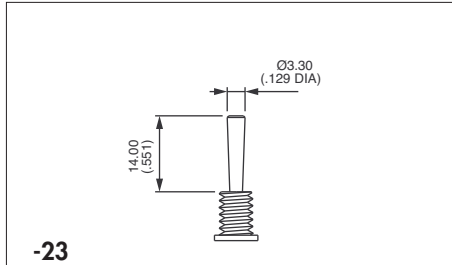

-23

Not available with sealing options K or X408

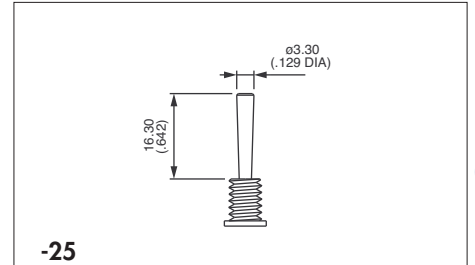

-25

Not available with sealing options K or X408

Levers for threaded bushing models Ø 11,9 (15/32) : 5600M

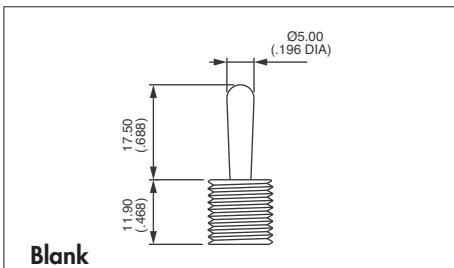

Blank

Standard

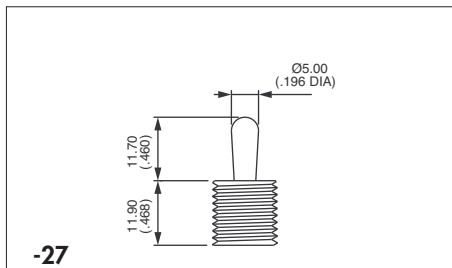

-27

Locking levers

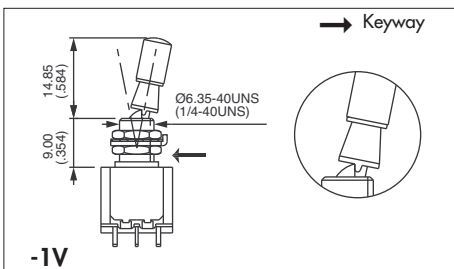

-1V

1 locked position (function 6)

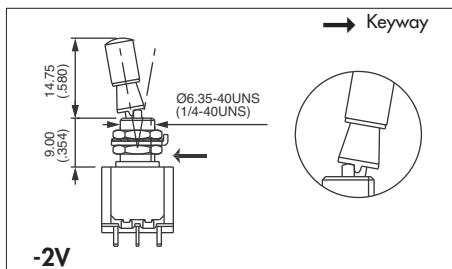

-2V

2 locked positions (function 6)

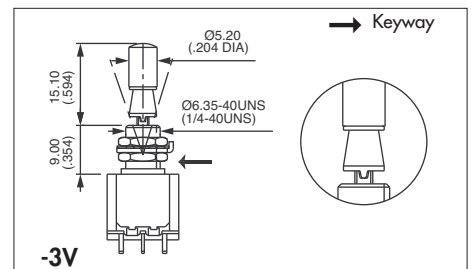

-3V

3 locked positions (functions 9 and 4)

Consult factory for other locking lever options.



Available with Ø 6,35 mm (1/4) threaded bushing models only.
For plain bushing models, see X386 or X916 under "Special options" on the following pages.

5000 series

Toggle switches

OPTIONS



ACTUATORS (continued)

For plain bushing models : W - WW and Y

A

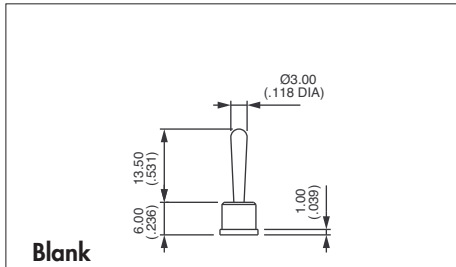

Blank

Standard

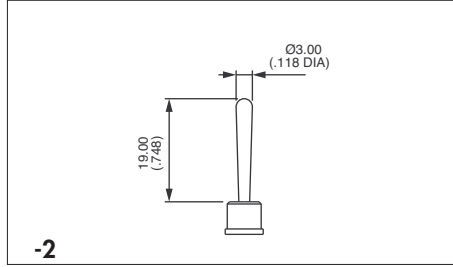

-2

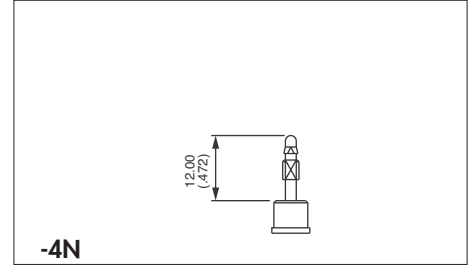

-4N

For use with paddles only

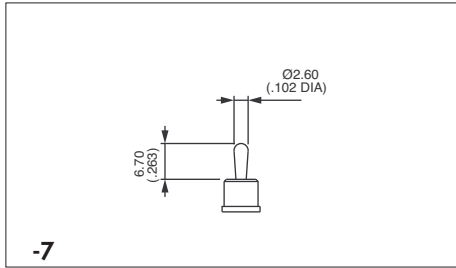

-7

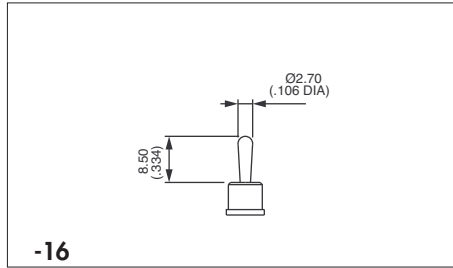

-16

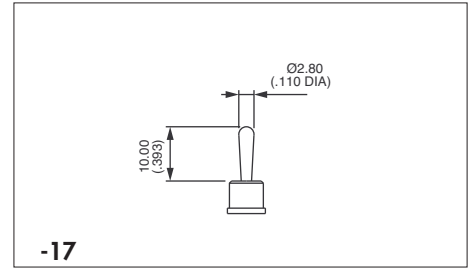

-17

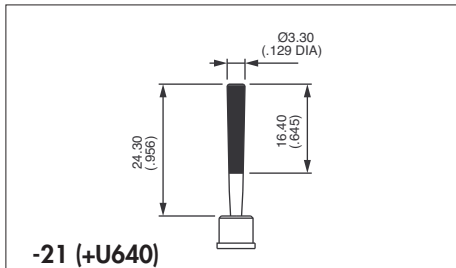

-21 (+U640)

U640 to be placed in last box of ordering format. Replace 0 by colour code.

Actuator colours

Replace "0" by number

1	blue
1/4	dark blue
2	black
3	green
4	grey
5	yellow
6	red
7	ivory
7/1	white
9	orange



LEVER LENGTH

With bracket or mounting plate lever length will be reduced by 0,4 mm (.015) as a rule. Please refer to switch technical drawings in "Model Structure" pages for details.



5000 series

Toggle switches

SPECIAL OPTIONS

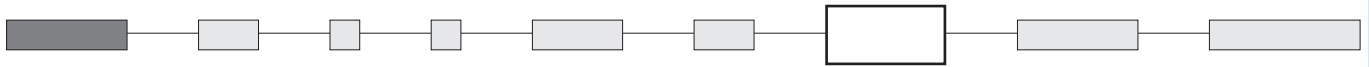

Blank No special requirement

X408 Front panel sealing by two O-rings. Flatted bushing for precise orientation. Protects the switch against water and dust. Panel seal withstands 1 bar pressure and remains sealed even when switch is operated. Includes sealed terminals (option B).



Available only on models with threaded bushing except 5600M. Not available with levers 8, 9, 12, 22, 23.

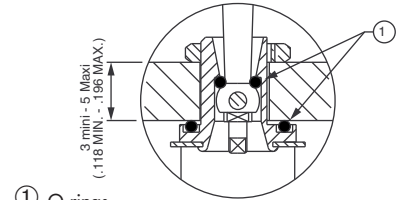

① O-rings

X404 Horizontal right angle with reduced overall dimensions (shown with lever -16)

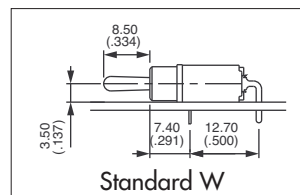

Standard W

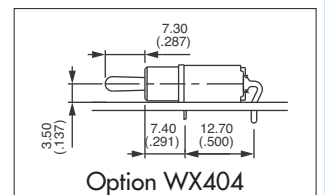

Option WX404



	III	II	I
	2-3		1-2
	5-6		4-5
Single pole			
5236W X404	5246W X404	ON -	ON
5239W X404	5249W X404	ON OFF	ON
5237W X404	5247W X404	MOM OFF	MOM
5238W X404	5248W X404	ON OFF	MOM
5232W X404	5242W X404	ON -	MOM
	5244W X404*	ON ON	ON
	5244W1R X404*	ON ON	MOM
	5244W2R X404*	MOM ON	MOM

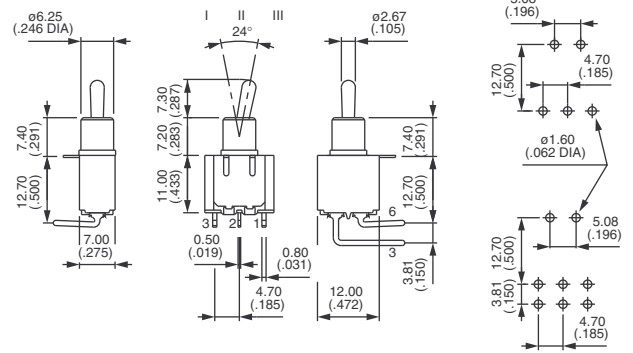

* Function 4 : SP in DP case - specify CT or TH connections, see end of catalogue.

Levers lengths for WX404 (also available with X445 option)

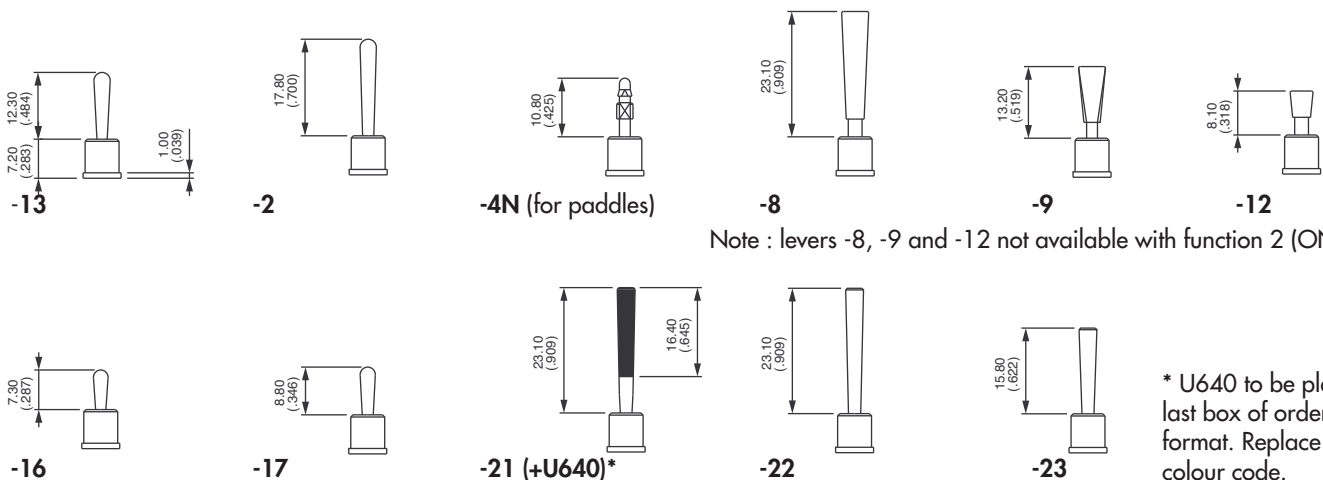

Note : levers -8, -9 and -12 not available with function 2 (ON-MOM)

* U640 to be placed in last box of ordering format. Replace 0 by colour code.

Insulating caps and paddles for X404 :

Insulating cap U1710 available with lever style 16.

Paddles U240N, U290N and U390N available with lever style 4N. See details on next pages.

5000 series

Toggle switches

OPTIONS



SPECIAL OPTIONS (continued)



With options X372, X386, X442 and X445, the lever lengths indicated on previous pages will be modified.

X371 Plain bushing \varnothing 6,25 mm (.246) (instead of standard threaded bushing).

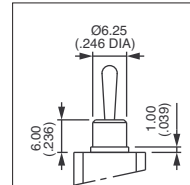

X371

X372 Threaded bushing \varnothing 6,35 (1/4). **Height 7 mm (.274)**.

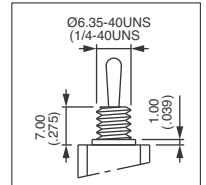

X372

X386 Threaded bushing \varnothing 6,35 mm (1/4) to replace plain bushing on models W - WW and Y.

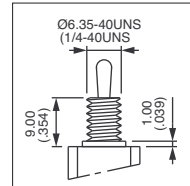

X386

X442 Threaded bushing \varnothing 6,35 mm (1/4) - **Height 9,9 mm (.389)**.

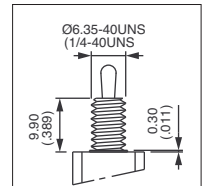

X442

X445 Plain bushing. **Height 7,2 mm (.283)** - for W, WW and Y models. Available with the same levers, insulating cap and paddles as X404.

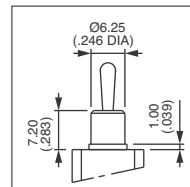

X445

X601 **Silver plated brass contacts.**
Current/voltage rating for an electrical life of 20.000 cycles : 0,5A 30VDC.
Minimum quantity : 5.000 pieces per model and shipment.

X681 **Satin chrome** actuator

X814 **Switches for peak currents**

Peak current up to 120A (1 ms) 60VDC - single/double pole



Single pole
5636A X814 ON - ON

Double pole
5646A X814 ON - ON

- Contacts : silver/nickel alloy (AgNi)
- Max. current/voltage rating : 2/120A (1 ms) 60VDC - 10.000 cycles
- Further specifications and dimensions : see 5600 series.
- General information on peak currents : see end of catalogue.

X902 Plain bushing \varnothing 6,25 mm (.246) - **Height 9 mm (.354)** (not available with K sealing option).

X916 Locking lever on model with plain bushing.

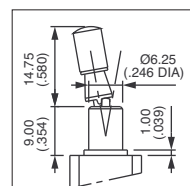

X916



AGENCY APPROVALS

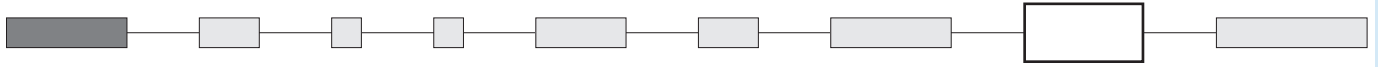

UL All standard models, except 5200MIWR
CSA
CECC Standard models 5600 - 5200

Availability : consult factory for details of approved combinations or options.

Marking : to order switches marked UL, CSA or CECC, complete above box with desired approvals, in this order & without space (ex. : ULCSACECC). Blank : no agency approval required.

VDE (with UL & CSA) Refer to 55000 series on the following pages.

Preferential lists : see specifications.

INSULATING CAPS AND PADDLES

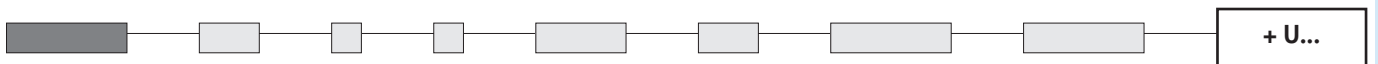

Insulating caps

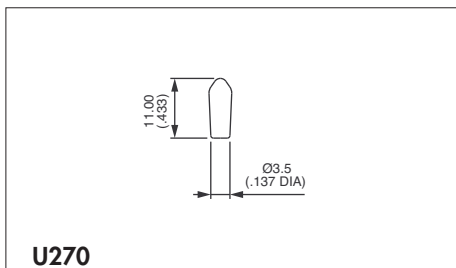

U270

For standard lever & threaded bushing only

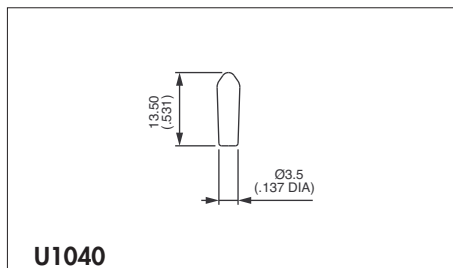

U1040

For standard lever & plain bushing only

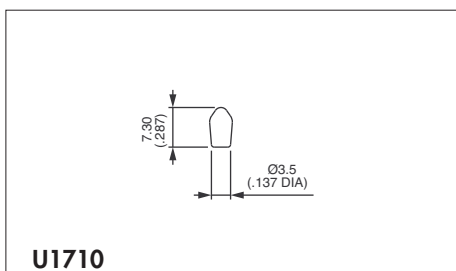

U1710

For lever 17 and threaded bushing
 For lever 7 and plain bushing

Cap colours	
Replace last "0" by number	
1	blue
1/4	dark blue
2	black
3	green
4	grey
5	yellow
6	red
7/1	white
9	orange



Insulating caps are not available in ivory colour.

5000 series

Toggle switches

OPTIONS



INSULATED CAPS AND PADDLES (continued)

Paddles

For use with lever 4N only. Shown with standard threaded bushing. Order separately.

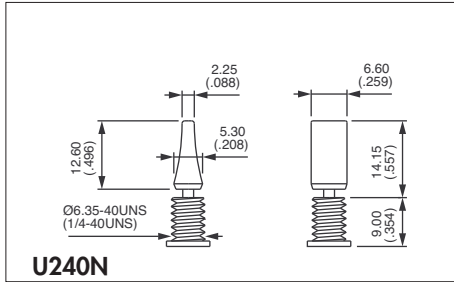

U240N

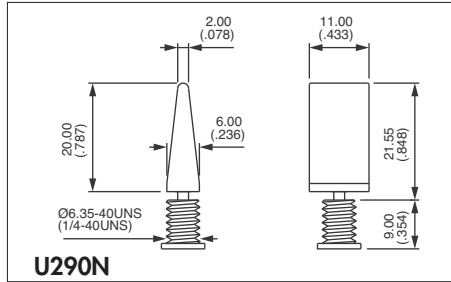

U290N

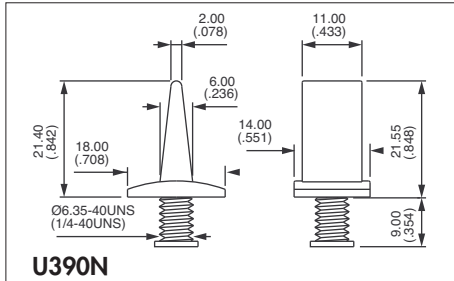

U390N

Paddle colours

Replace last "0" by number

- 1 blue
- 1/4 dark blue
- 2 black
- 3 green
- 4 grey
- 5 yellow
- 6 red
- 7 ivory
- 7/1 white
- 9 orange

A